

## Touring Speakers

# LIVERPOOL

## TLX43

Compact Dual 2 Way 4" Line Array Element for Portable and Fixed Installation Applications



- Compact 2 way line array element for portable and fixed installation application
- 150 Watts continuous, 600 Watts peak power
- Ideal for FOH, center cluster, offstage fill, stereo in-fill or distributed fill applications
- Dual Kevlar cone 4" low frequency drivers
- Titanium dome 1" pure aluminium coil compression driver
- Integral rigging system for suspending or ground stacking multiple TLX43 elements
- Wide 120° H x 10° V dispersion for even coverage
- Bi-amp operation for high output and controlled dispersion
- 12 mm (½") plywood enclosure with hard wearing semi matt black paint finish
- Powder coated perforated steel mesh grille
- Neutrik speakON\* NL4 connectors for reliable long life operation
- Compatible with TLX212L dual 12" subwoofer
- 3-Year Warranty Program\*
- Designed and engineered in the U.K.

The 2-way full range TLX43 is a compact bi-amplified dual 4" 600-Watt line array element that is ideally suited to a broad range of speech and music sound reinforcement applications in fixed installation, portable and touring audio systems. The TLX43 is designed to work in conjunction with LAKE DSP and LAB GRUPPEN amplification, providing optimal FOH performance, as well as offering considerable flexibility to readily adapt to varying venue requirements.

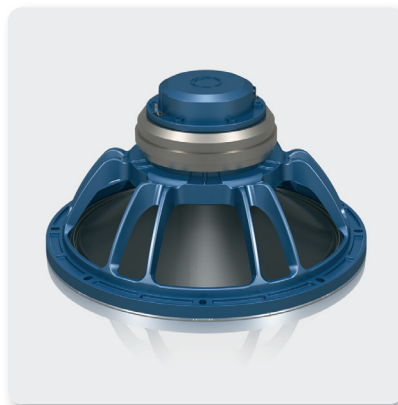

the TLX43 provides exceptional coverage in wide rooms and in distributed fill applications.

### Custom-Engineered Drivers

TURBOSOUND is recognised the world over for designing and building some of the most iconic loudspeakers and subwoofers. We take meticulous care and pride in maintaining that reputation by utilising only drivers designed specifically for each application – it's what sets us apart from the competition.

Featuring two 4" Kevlar\* cone low frequency drivers and a 1" titanium dome pure aluminium coil compression driver, the TLX43 delivers unparalleled clarity and intelligibility in a compact enclosure that belies its impressive performance. Due to its broad 120° horizontal by 10° vertical dispersion pattern,

\*All third-party trademarks are the property of their respective owners. Their use neither constitutes a claim of the trademark nor affiliation of the trademark owners with MUSIC Group. Product names are mentioned solely as a reference for compatibility, effects and/or components. Warranty details can be found at music-group.com.

Touring Speakers

# LIVERPOOL

## TLX43

Compact Dual 2 Way 4" Line Array Element for Portable and Fixed Installation Applications

### Construction and Connectivity

An integral suspension system engineered to meet BGV-C1 specifications is provided for suspending or ground stacking multiple TLX43 elements per hang with a 10:1 safety factor. Designed for speed and simplicity of use, custom-engineered flybars and road cases are available as separate accessories. The companion TLX212L dual 12" subwoofer is specifically designed for use with TLX43, providing additional low frequency extension and impact for more demanding sound reinforcement applications. Finished in hard wearing semi matt black paint, the cabinet is constructed from 12 mm (½") birch plywood and includes a rugged powder coated perforated steel mesh grille backed with reticulated foam. The rear panel connector plate carries Neutrik speakON® NL4 connectors for input and link connections to additional enclosures.

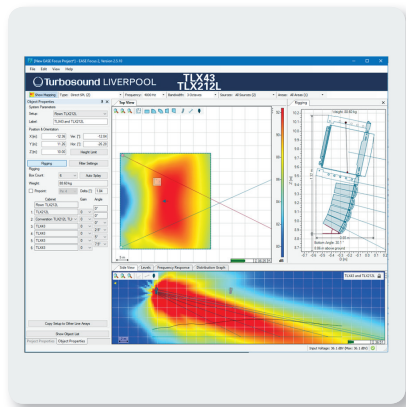

### Acoustic Simulation Tools

EASE GLL files are provided for EASE Focus Acoustic Simulation Software, which is available for free download. This allows accurate calculation of both acoustic coverage and suspension pick point selection for tilting and aiming the array at the desired angle.

### You Are Covered

We always strive to provide the best possible Customer Experience. Our products are made in our own MUSIC Group factory using state-of-the-art automation, enhanced production workflows and quality assurance labs with the most sophisticated test equipment available in the world. As a result, we have one of the lowest product failure rates in the industry, and we confidently back it up with a generous 3-Year Warranty program.



Touring Speakers

# LIVERPOOL

## TLX43

Compact Dual 2 Way 4" Line Array Element for Portable and Fixed Installation Applications

### Frequency Response Sensitivity 1 W / 1 m

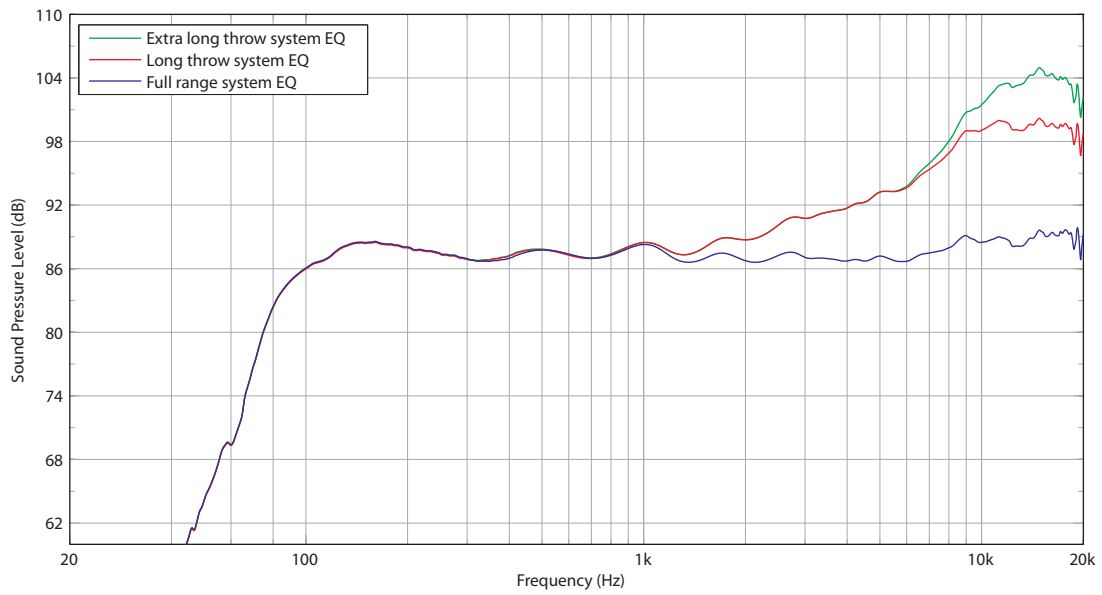

### Impedance

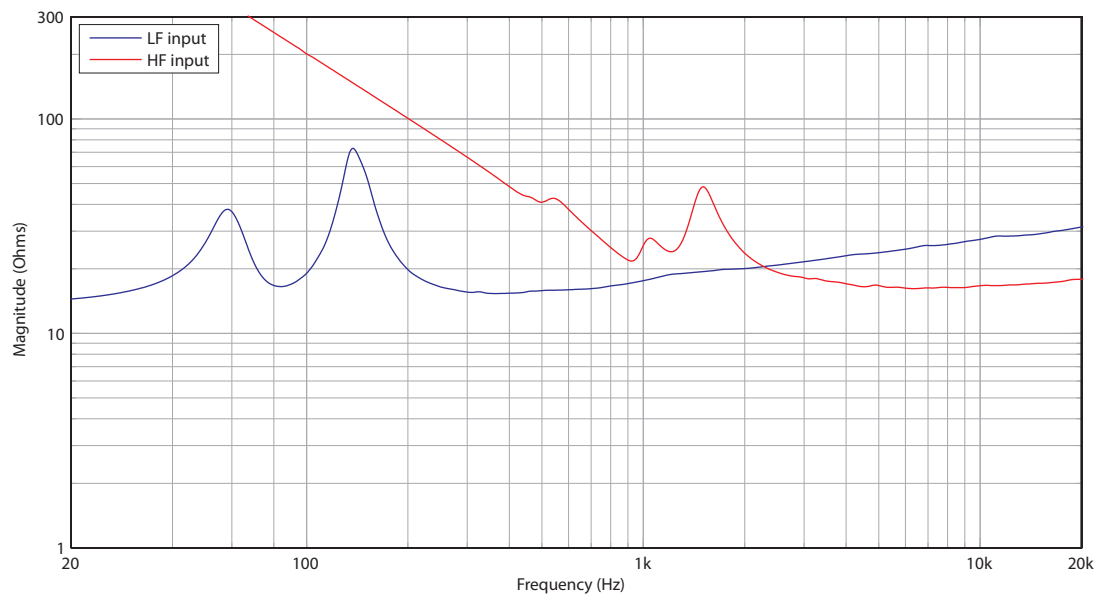

Touring Speakers

# LIVERPOOL

## TLX43

Compact Dual 2 Way 4" Line Array Element for Portable and Fixed Installation Applications

### Horizontal Beamwidth

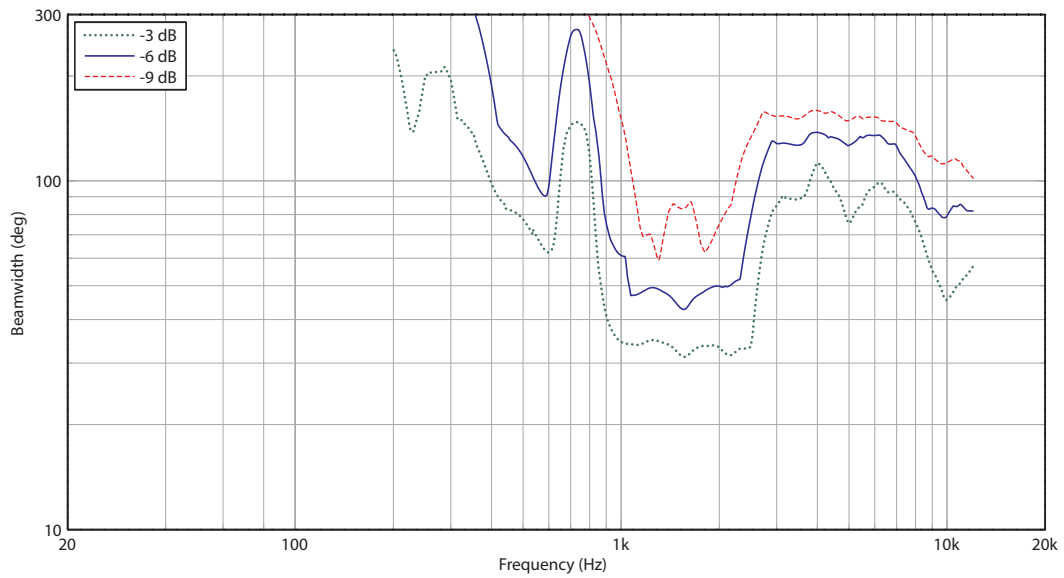

### Vertical Beamwidth

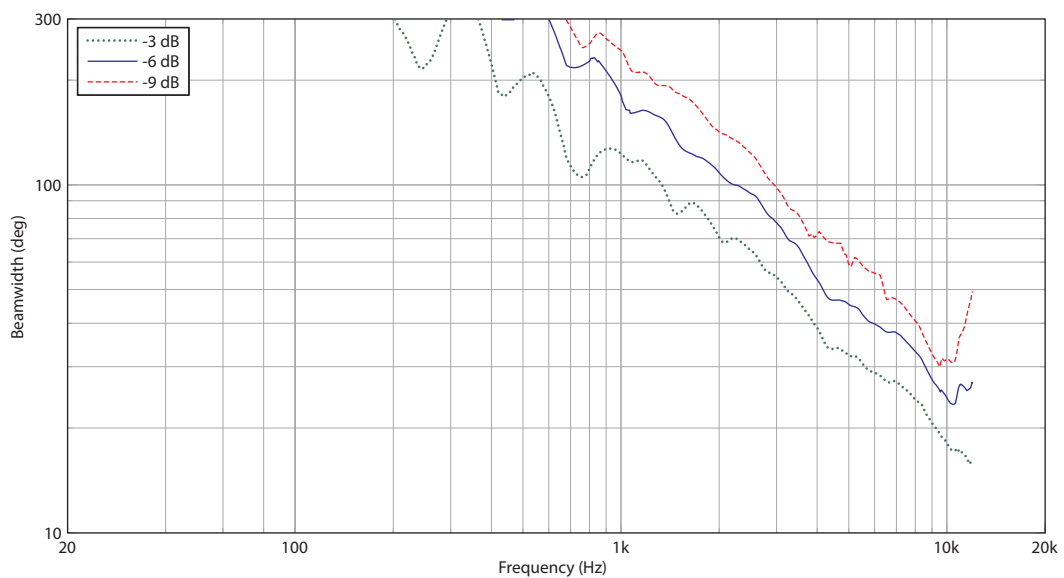

Touring Speakers

# LIVERPOOL

## TLX43

Compact Dual 2 Way 4" Line Array Element for Portable and Fixed Installation Applications

### Horizontal Polar Plots

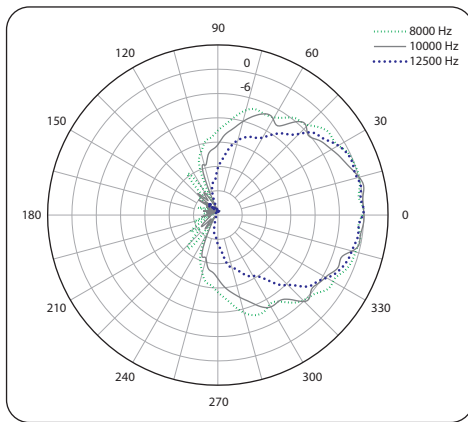
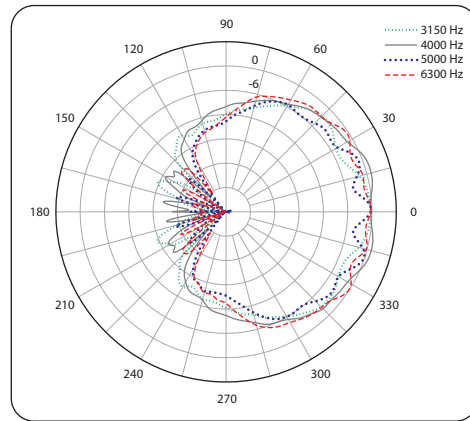
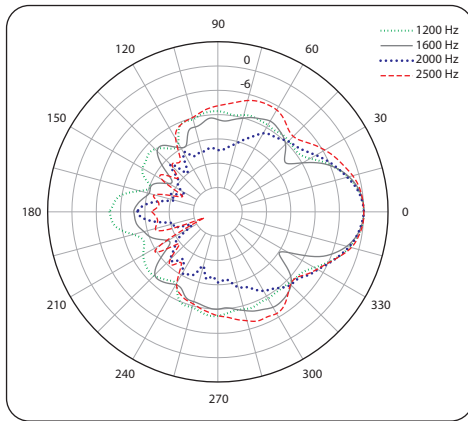
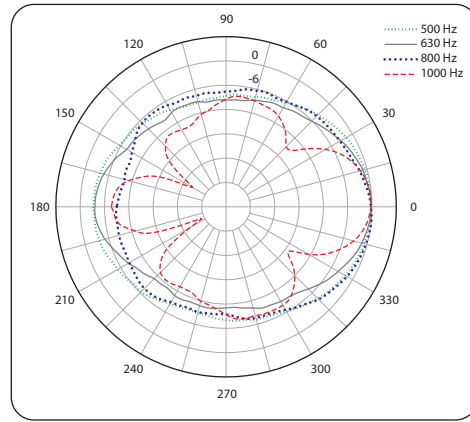
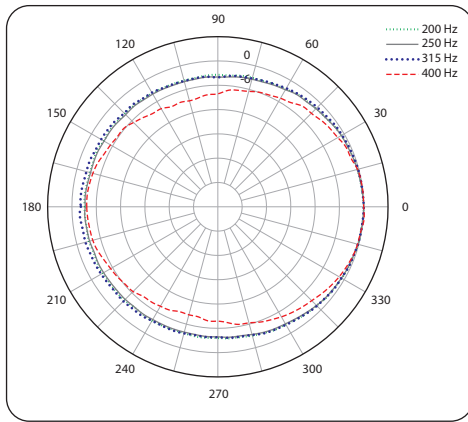

Touring Speakers

# LIVERPOOL

## TLX43

Compact Dual 2 Way 4" Line Array Element for Portable and Fixed Installation Applications

### Vertical Polar Plots

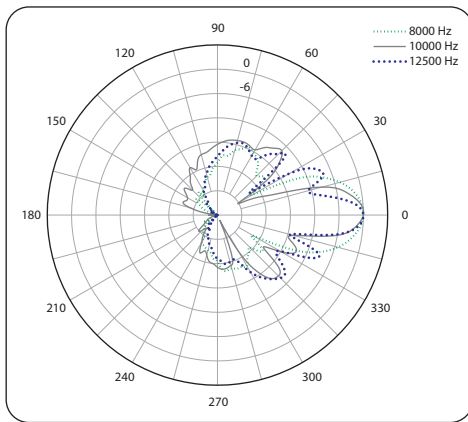
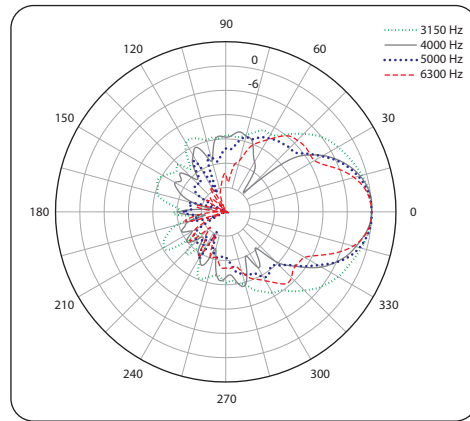
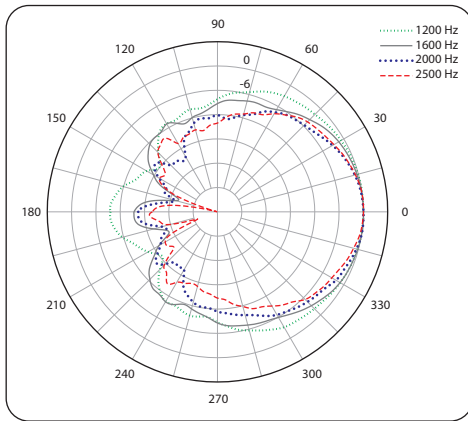
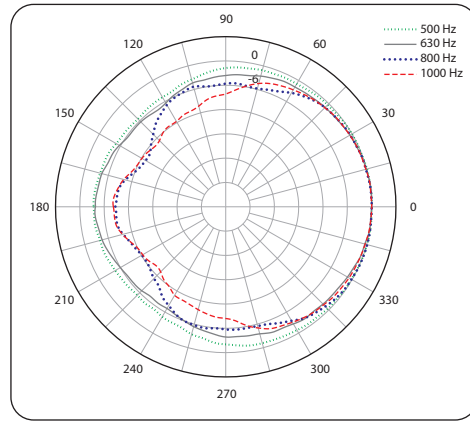
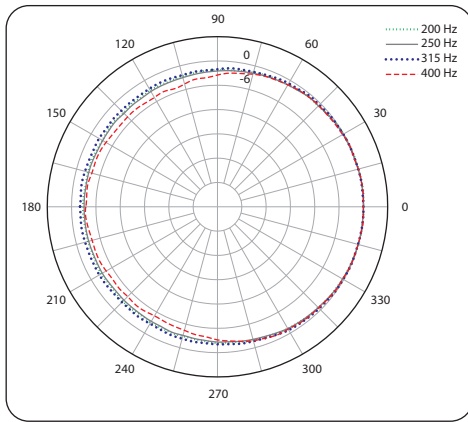

Touring Speakers

# LIVERPOOL

## TLX43

Compact Dual 2 Way 4" Line Array Element for Portable and Fixed Installation Applications

### Dimensions

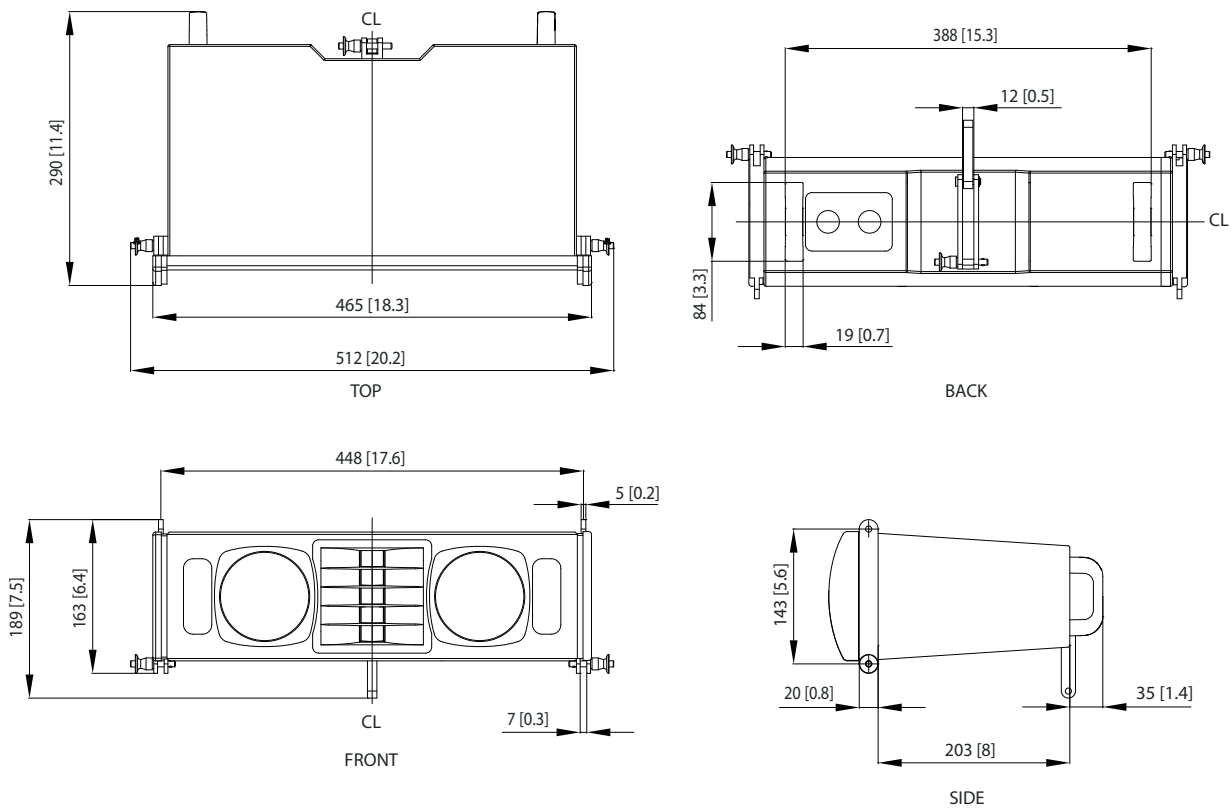

Touring Speakers

# LIVERPOOL

## TLX43

Compact Dual 2 Way 4" Line Array Element for Portable and Fixed Installation Applications

### Mounting and Rigging

**⚠ Safety Warning:** Only authorised and certified personnel shall design and install suspended or ground stack configurations, following the instructions and procedures in the TLX43-FLB rigging manual supplied with the TLX43-FLB flybar, or downloaded from [turbosound.com](http://turbosound.com). Failure to follow these instructions may lead to death or permanent injury. For maximum array sizes, weights and working load limits, please consult the TLX43-FLB rigging manual.

The TLX43 cabinet has fixed mounting lugs at the top and bottom, a choice of 4 mounting holes at the rear, and a rear drop-down link. These allow the TLX43 cabinets to be connected together, and attached to the TLX43-FLB flybar. Rigging pins are provided to secure the cabinets and TLX43-FLB flybar together. The cabinet angle can be varied by selecting one of the 4 rear mounting holes to select 0, 2.5, 5.0 or 7.5 degree inter-cabinet angles.

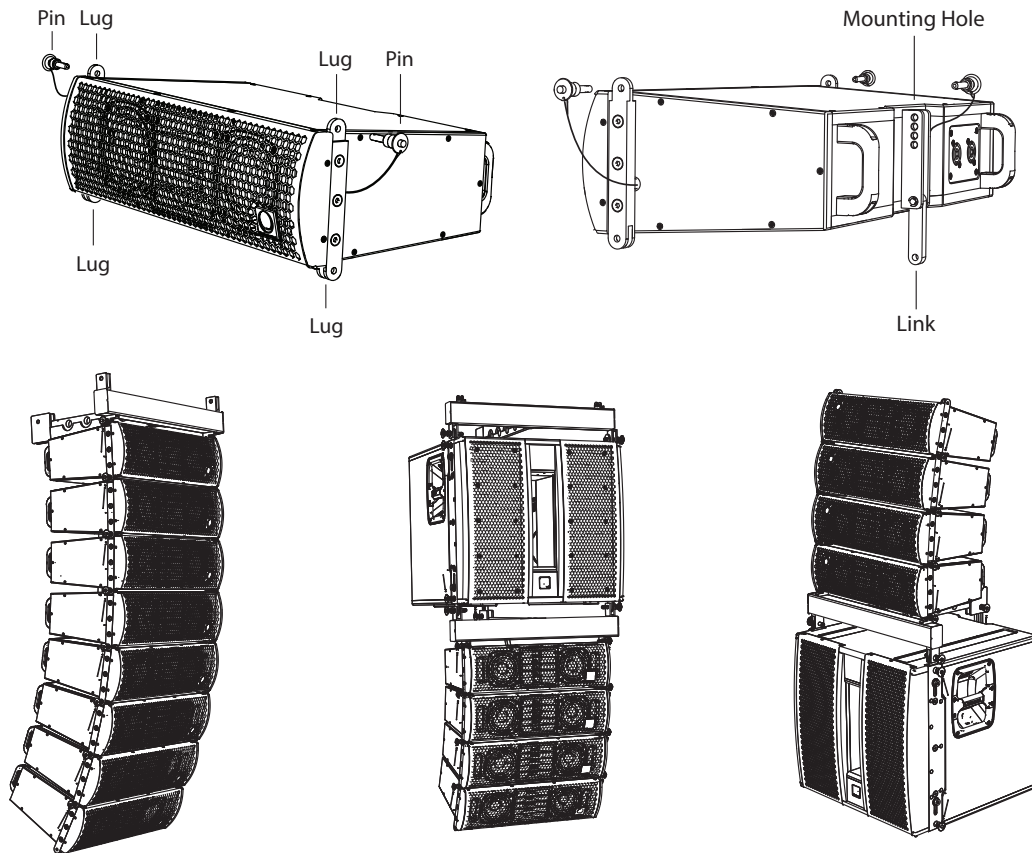

An array of 8 TLX43 cabinets attached to a TLX43-FLB flybar

A mixed array with a TLX212L subwoofer, 4 TLX43 cabinets and 2 TLX43-FLB flybars

A mixed array ground stack with a TLX212L subwoofer, 4 TLX43 cabinets and a TLX43-FLB flybar



## Touring Speakers

# LIVERPOOL

## TLX43

Compact Dual 2 Way 4" Line Array Element for Portable and Fixed Installation Applications

### Technical Specifications

#### System

Frequency Response	85 Hz – 20 kHz $\pm$ 3 dB 70 Hz – 20 kHz -10 dB
Nominal Dispersion	120° H x 10° V @ -6 dB points
Power Handling (IEC)	LF: 150 W continuous, 600 W peak HF: 30 W continuous, 120 W peak
Sensitivity	LF: 87 dB (1 W @ 1 m) HF: 99 dB (1 W @ 1 m)
Maximum SPL	LF: 109 dB continuous, 115 dB peak HF: 114 dB continuous, 120 dB peak
Impedance	LF: 16 $\Omega$ HF: 16 $\Omega$
Crossover Type	External bi-amp
Components	2 x 4" (102 mm) LF driver 1 x 1" (25.4 mm) HF compression driver

#### Enclosure

Connectors	2 x Neutrik speakON* NL4
Wiring	Pins 1+ / 1- LF, pins 2+ / 2- HF
Dimensions H x W x D	163 x 512 x 290 mm (6.4 x 20.2 x 11.4")
Net Weight	8.0 kg (17.6 lbs)
Construction	12 mm (1/2") plywood
Finish	Semi matt black paint
Grille	Powder coated perforated steel
Suspension Hardware	Integral variable curvature

#### Accessories

TLX43-FLB fly bar
TLX43-RC4 road case

Touring Speakers

# LIVERPOOL

## TLX43

Compact Dual 2 Way 4" Line Array Element for  
Portable and Fixed Installation Applications

### Architecture & Engineering Specifications

The loudspeaker shall be of the two-way bi-amp passive type consisting of two 4" (102 mm) LF drivers and one 1" (25.4 mm) HF compression driver. Performance specifications of a typical production unit shall meet or exceed the following: frequency response, measured with swept sine wave input, shall be flat within  $\pm 3$  dB from 85 Hz to 20 kHz and within -10 dB from 70 Hz to 20 kHz. Nominal dispersion, at -6 dB points, shall average  $120^{\circ}H \times 10^{\circ}V$ . Nominal impedance shall be HF: 16 Ohms, LF: 16 Ohms. Power handling shall be HF: 30 Watts continuous, 120 Watts peak, LF: 150 Watts continuous, 600 Watts peak. Sensitivity, measured on axis, mean averaged over the stated bandwidth, shall be HF: 99 dB, 1 Watt @ 1 metre, LF: 87 dB, 1 Watt @ 1 metre. Maximum SPL (peak), measured at 1 metre with music program at stated amplifier input, shall be HF: 120 dB, LF: 115 dB. Dimensions: 163 mm high x 512 mm wide x 290 mm deep (6.4" x 20.2" x 11.4"). Net weight: 8.0 kg (17.6 lbs). The loudspeaker system shall be the [TURBOSOUND TLX43](#). No other loudspeaker shall be acceptable unless submitted data from an independent test laboratory verifies that the above combined performance / size specifications are equaled or exceeded.

Touring Speakers

# LIVERPOOL

## TLX43

Compact Dual 2 Way 4" Line Array Element for Portable and Fixed Installation Applications



Touring Speakers

# LIVERPOOL

## TLX43

Compact Dual 2 Way 4" Line Array Element for  
Portable and Fixed Installation Applications

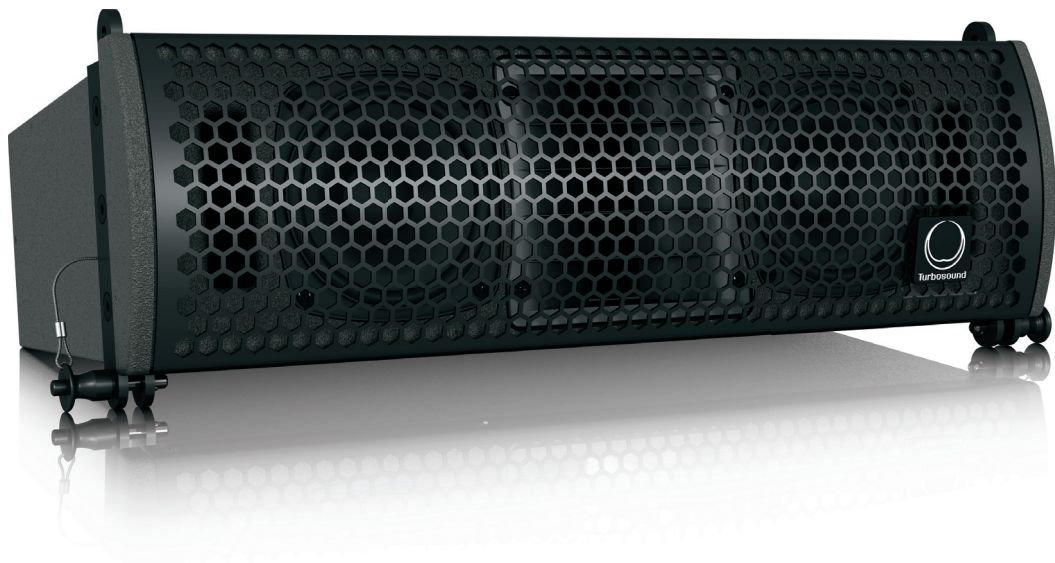

Touring Speakers

# LIVERPOOL

## TLX43

Compact Dual 2 Way 4" Line Array Element for Portable and Fixed Installation Applications



For service, support or more information contact the TURBOSOUND location nearest you:

**Europe**  
**MUSIC Group Services UK**  
Tel: +44 1562 547 100  
Email: CARE@music-group.com

**USA/Canada**  
**MUSIC Group Services NV Inc.**  
Tel: +1 702 963 1300  
Email: CARE@music-group.com

**Japan**  
**MUSIC Group Services JP K.K.**  
Tel: +81 3 5833 9121  
Email: CARE@music-group.com

MUSIC Group accepts no liability for any loss which may be suffered by any person who relies either wholly or in part upon any description, photograph, or statement contained herein. Technical specifications, appearances and other information are subject to change without notice. All trademarks are the property of their respective owners. MIDAS, KLARK TEKNIK, LAB GRUPPEN, LAKE, TANNÖY, TURBOSOUND, TC ELECTRONIC, TC HELICON, BEHRINGER, BUGERA and DDA are trademarks or registered trademarks of MUSIC Group IP Ltd.  
© MUSIC Group IP Ltd. 2017 All rights reserved.

